

Article number: 20330342

Description: E+G Handwheel
GN 555-250-K24-A

Measures

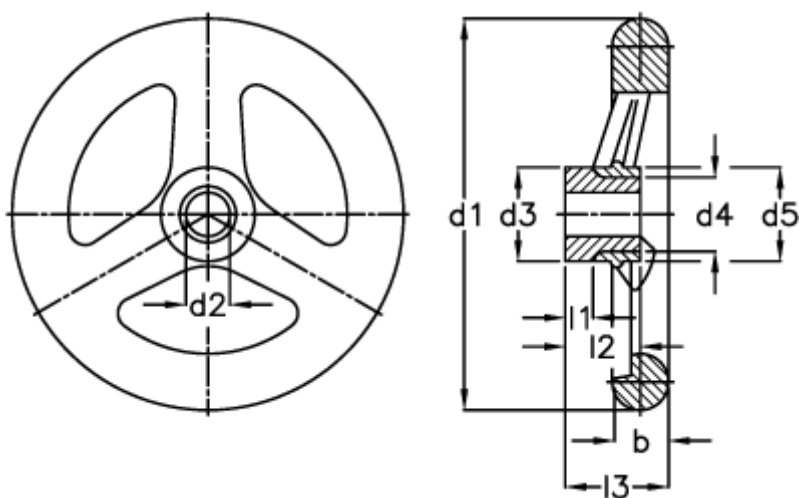

b	= 29	l2 -0.5	= 36
d1	= 250	l3	= 58
d2 H7	= 24	Number of spokes	= 3
d2 H7	= 22		
d3	= 49		
d4	= 38		
d5	= 56		
l1 -0.5	= 7		